

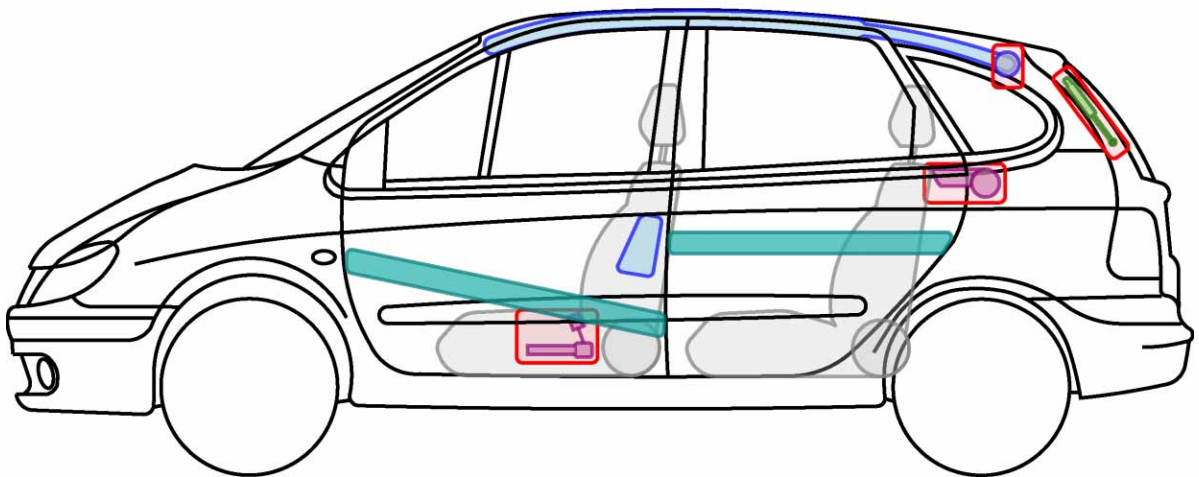

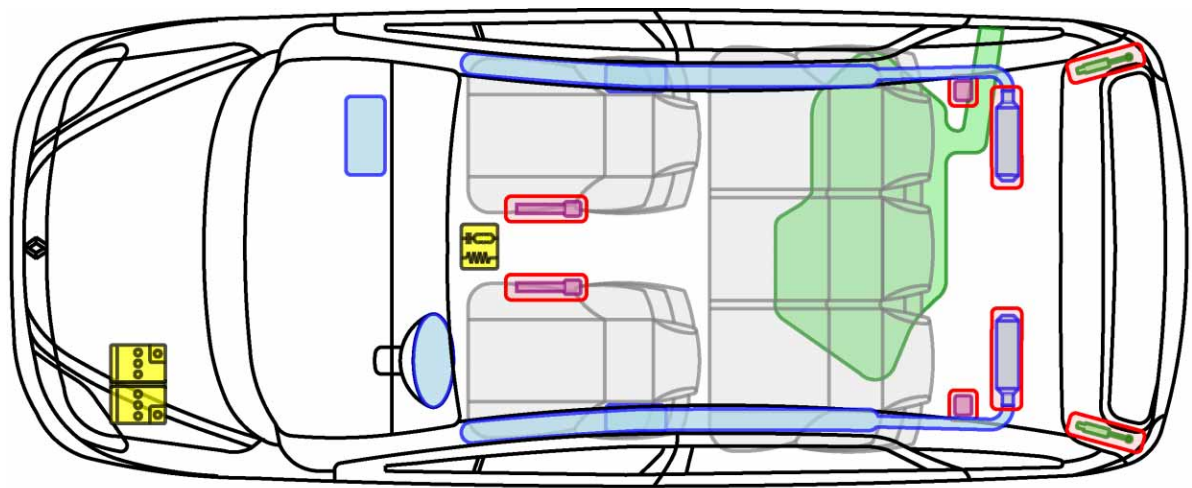

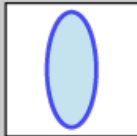

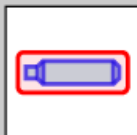

SCÉNIC I

TYP: JA, 1999-2003

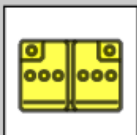





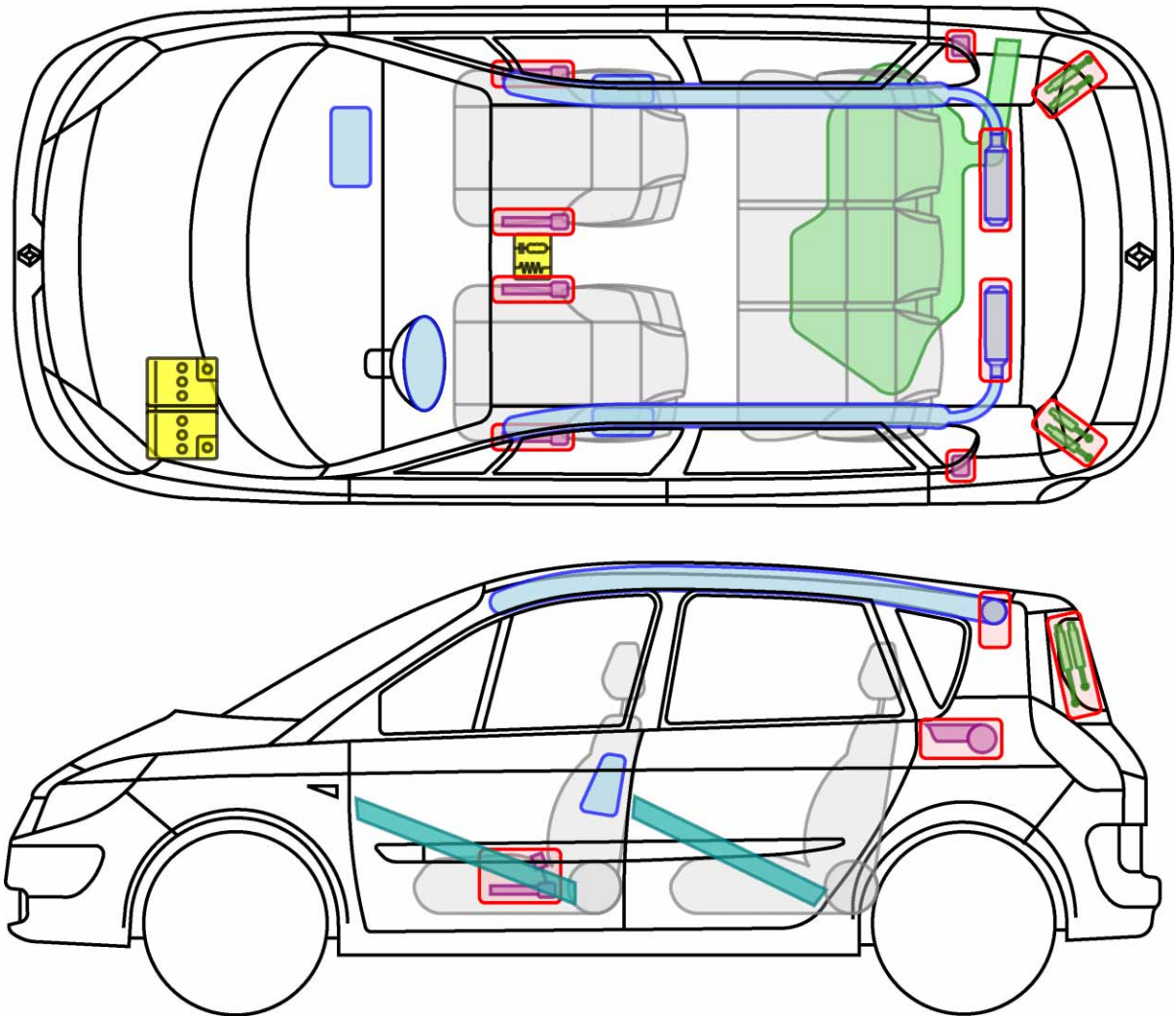



Legende

| | | | | | |
|---|---------------|---|------------------------|--|-----------------|
|  | Airbag |  | Karosserie-verstärkung |  | Steuergerät |
|  | Gas-generator |  | Überroll-schutz |  | Batterie |
|  | Gurt-straffer |  | Gasdruck-dämpfer |  | Kraftstoff-tank |



Legende

| | | | | | |
|---|-------------------|---|----------------------------|---|---------------------|
|  | Airbag |  | Karosserie- verstärkung |  | Steuergerät |
|  | Gas- generator |  | Überroll- schutz |  | Batterie |
|  | Gurt- straffer |  | Gasdruck- dämpfer |  | Kraftstoff- tank |



SCÉNIC III

TYP: JZ, 2009-

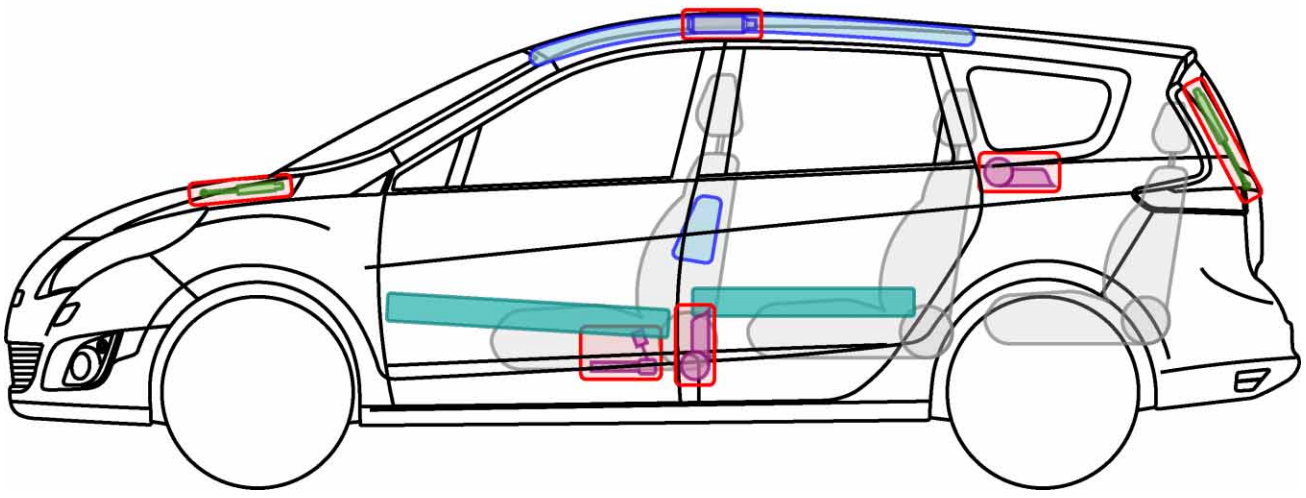
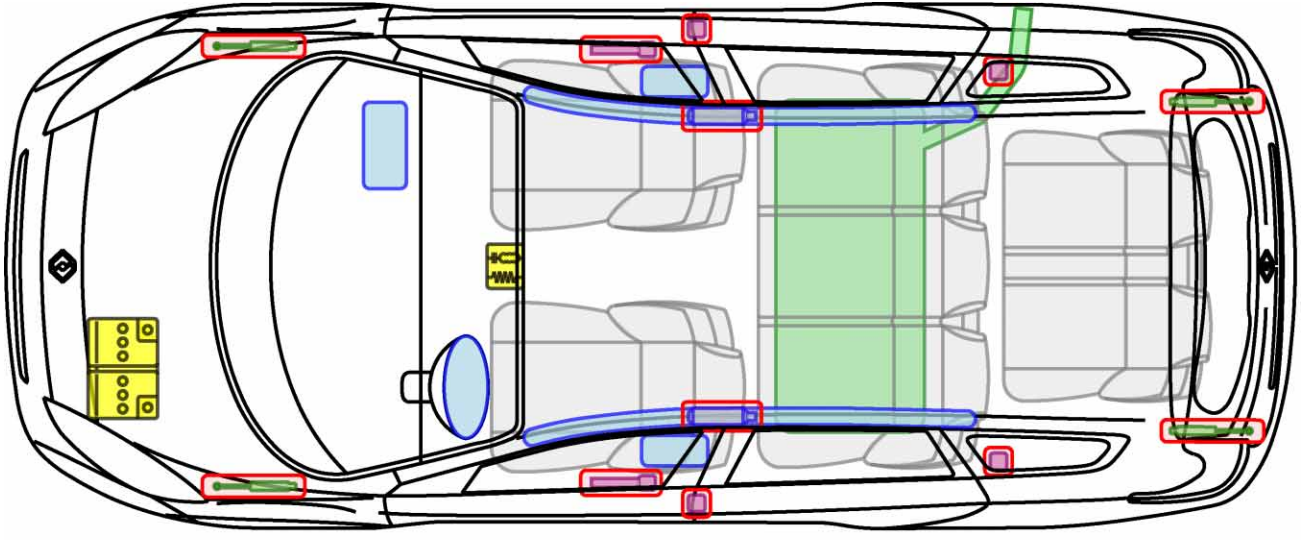







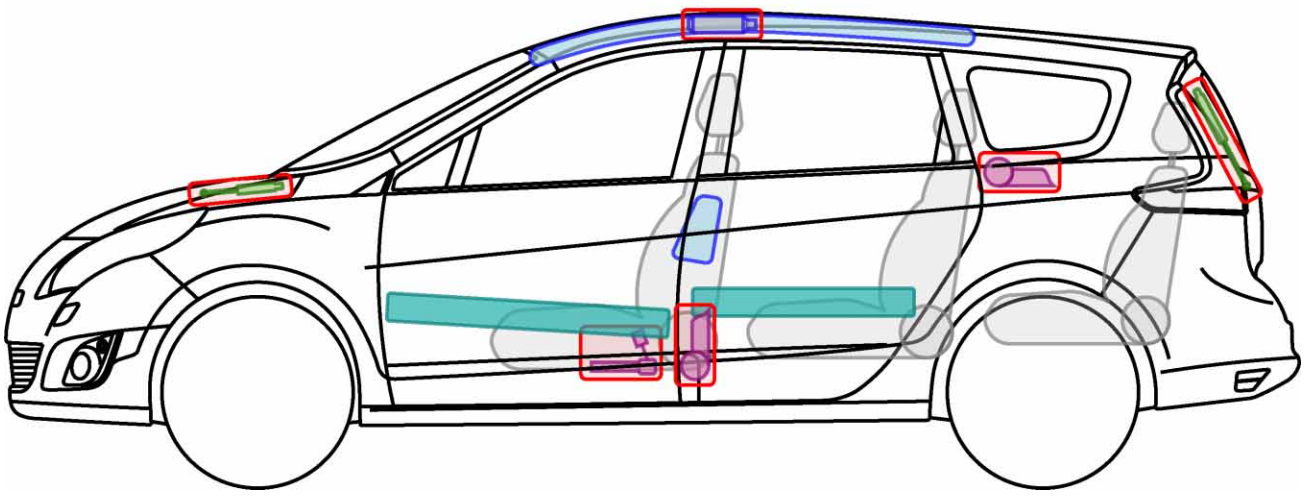
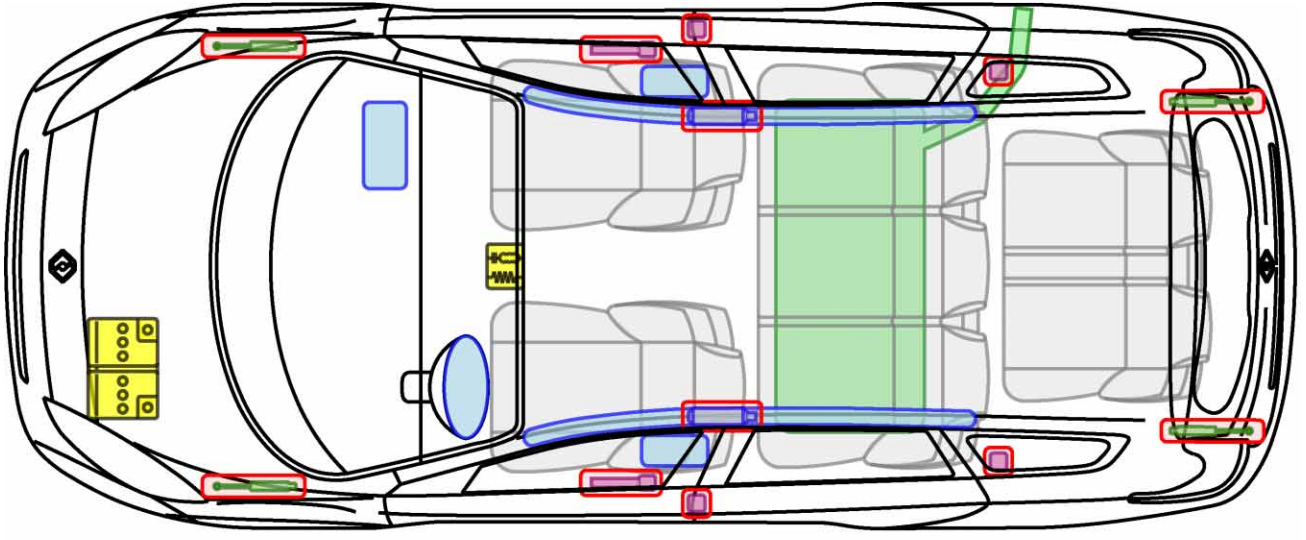

Legende

| | | | | | |
|--|---------------|--|------------------------|--|-----------------|
| | Airbag | | Karosserie-verstärkung | | Steuergerät |
| | Gas-generator | | Überroll-schutz | | Batterie |
| | Gurt-straffer | | Gasdruck-dämpfer | | Kraftstoff-tank |



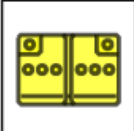

Legende

| | | | | | |
|---|-------------------|---|----------------------------|--|---------------------|
|  | Airbag |  | Karosserie- verstärkung |  | Steuergerät |
|  | Gas- generator |  | Überroll- schutz |  | Batterie |
|  | Gurt- straffer |  | Gasdruck- dämpfer |  | Kraftstoff- tank |