

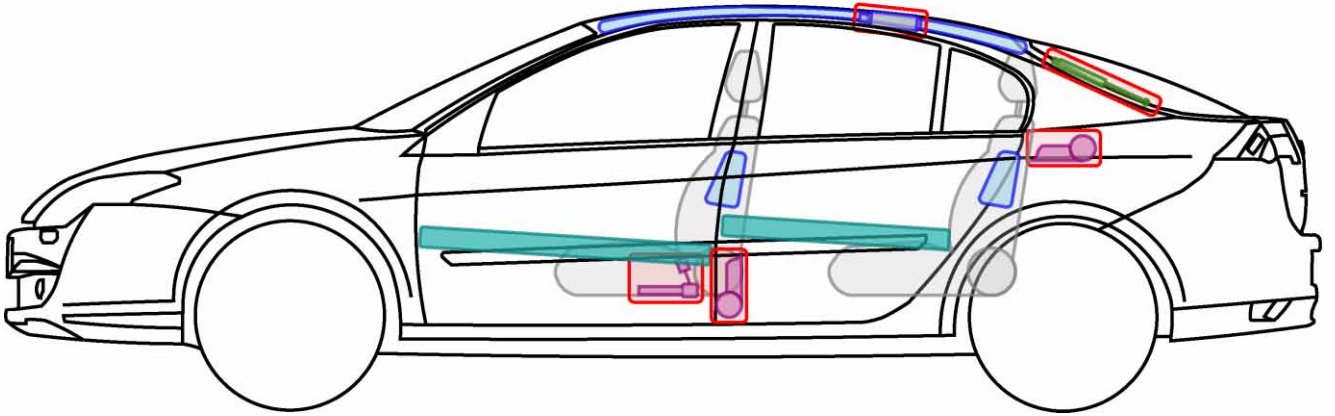

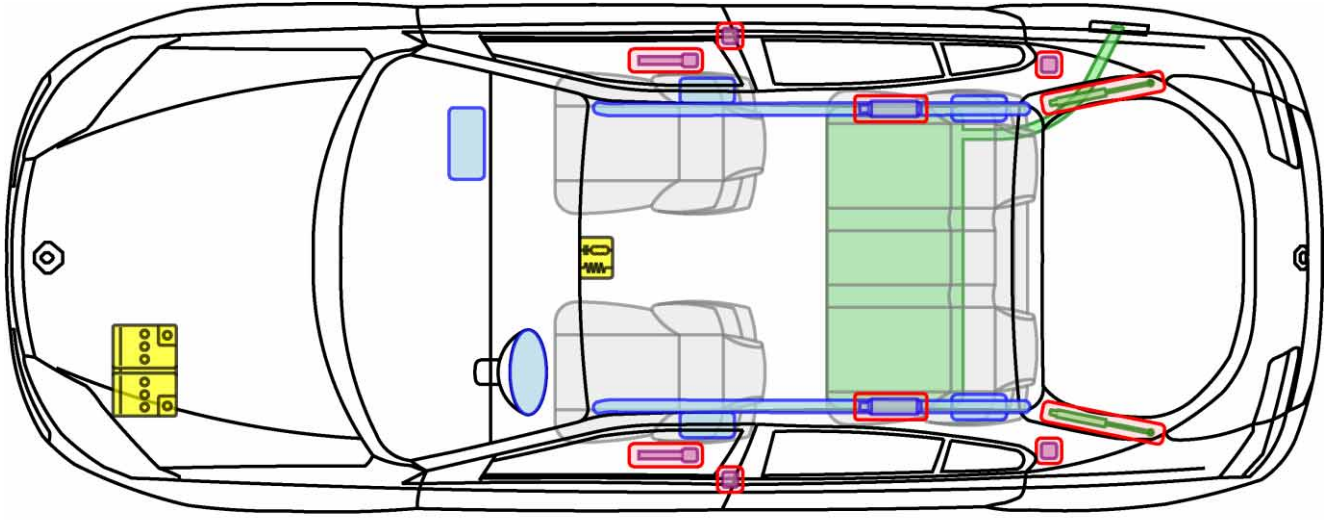









LAGUNA III

TYP: T, 2009-

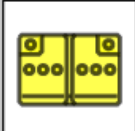





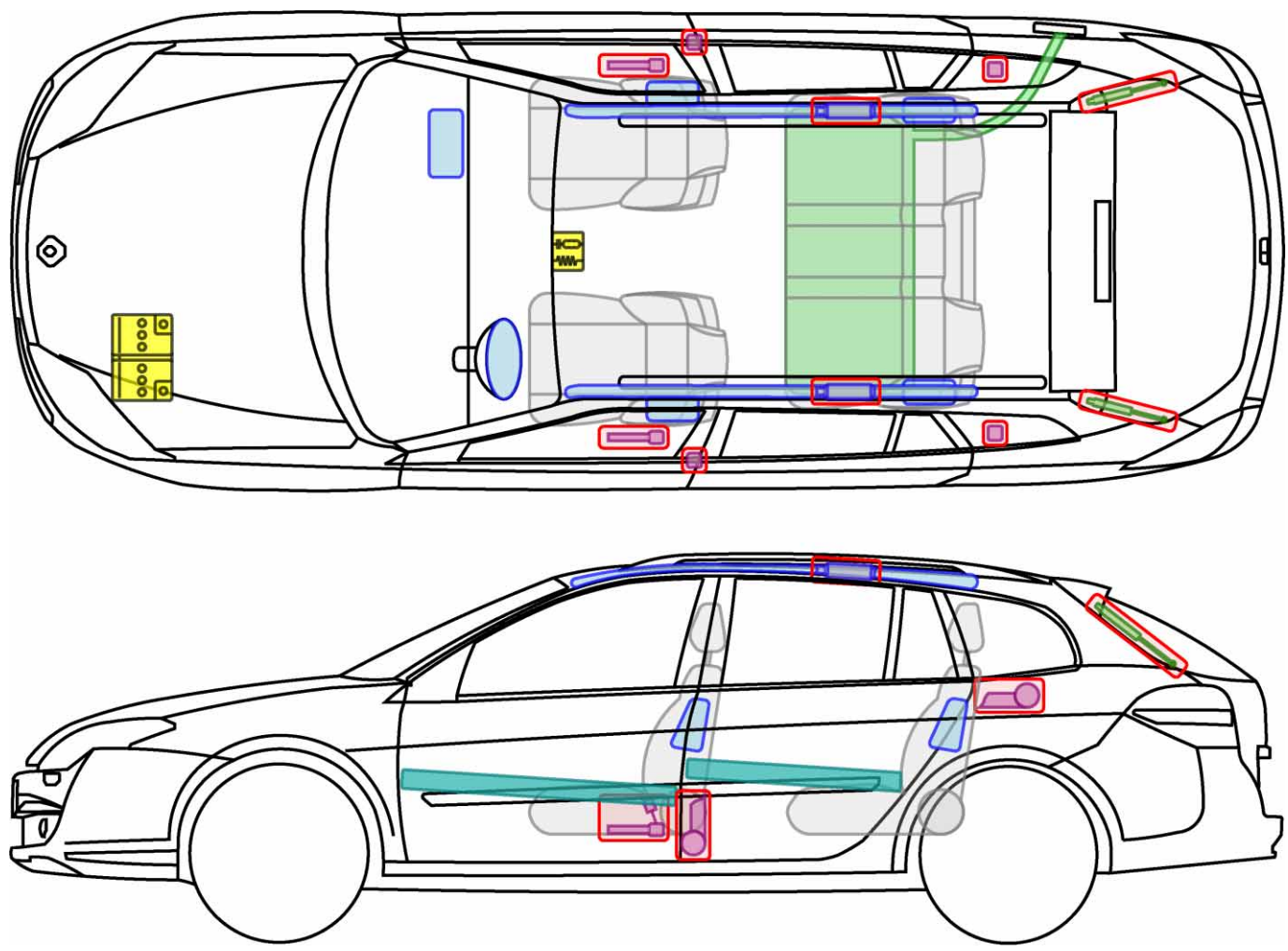

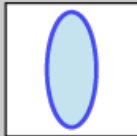

Legende

	Airbag		Karosserie- verstärkung		Steuergerät
	Gas- generator		Überroll- schutz		Batterie
	Gurt- straffer		Gasdruck- dämpfer		Kraftstoff- tank

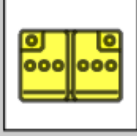





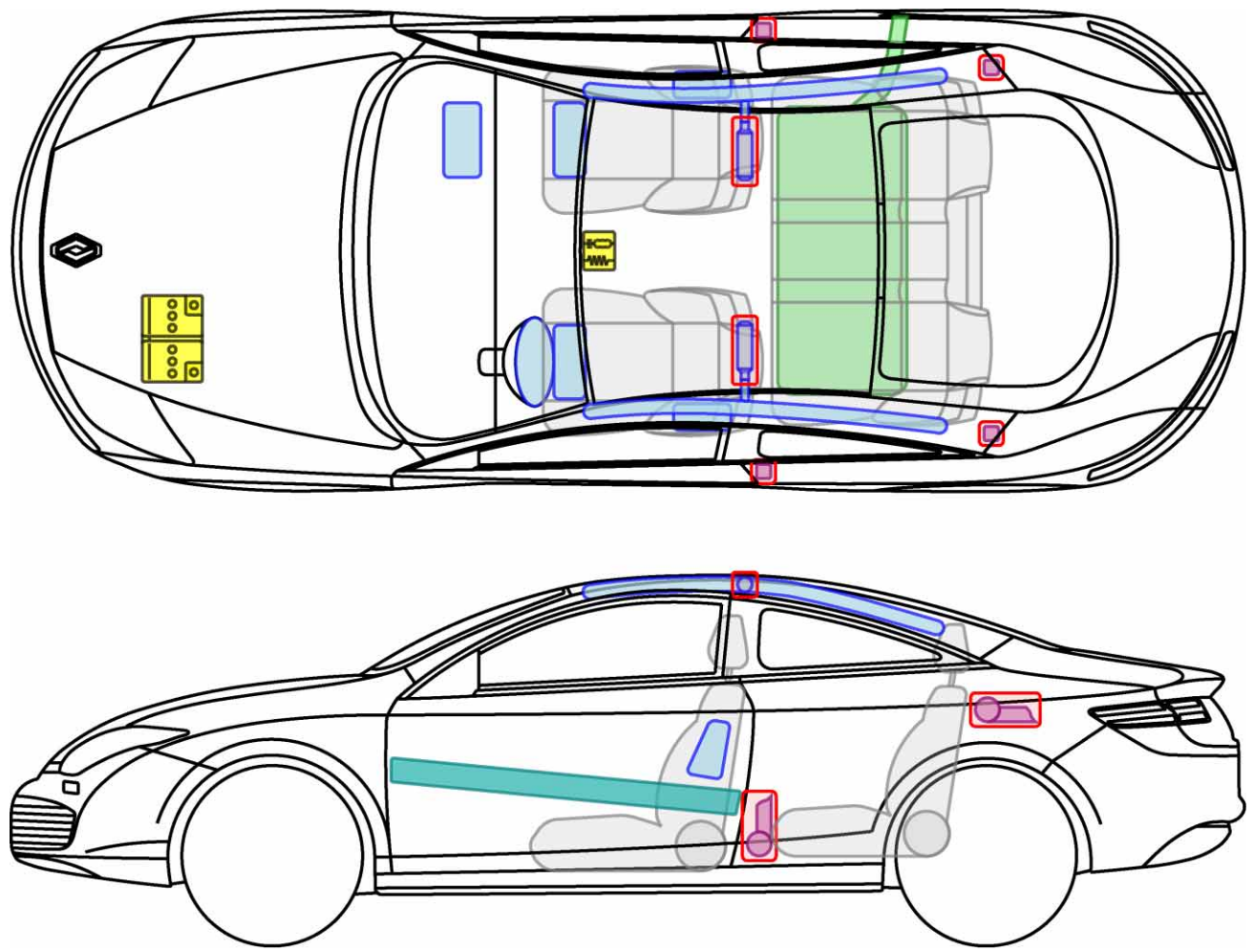

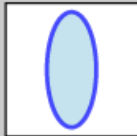

Legende

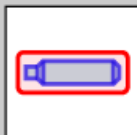
	Airbag		Karosserie-verstärkung		Steuergerät
	Gas-generator		Überroll-schutz		Batterie
	Gurt-straffer		Gasdruck-dämpfer		Kraftstoff-tank

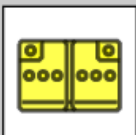

Legende

	Airbag		Karosserie-verstärkung		Steuergerät
	Gas-generator		Überroll-schutz		Batterie
	Gurt-straffer		Gasdruck-dämpfer		Kraftstoff-tank